

CUST. MODEL:	REF.
CUST. P/N:	DWG FILE:

DESCRIPTION CONTROL			
REV.	DESC.	DATE	APP.

**RoHS Compliance**

NOTE:  
ZINE ALLOY NI PLATED  
FOR OD=14.5mm CABLE

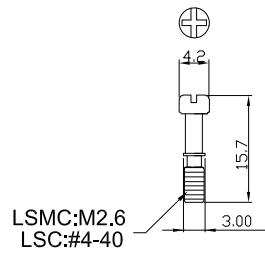

A  
2Pcs

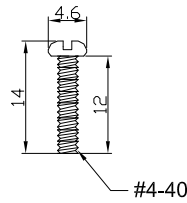

C  
2Pcs

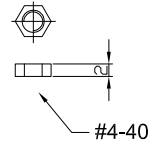

D  
2Pcs

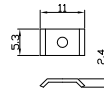

D  
2Pcs

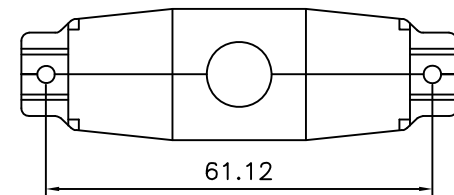
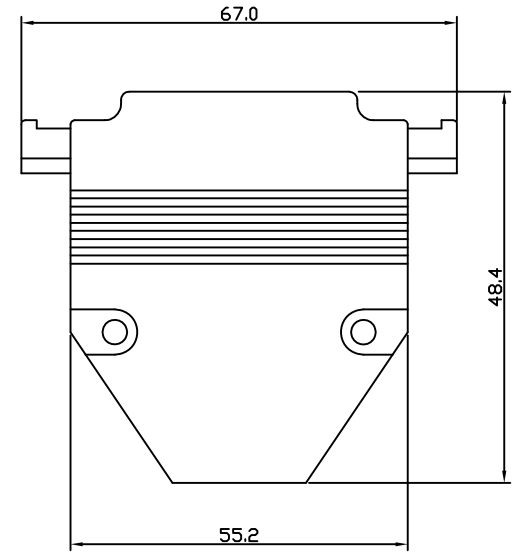
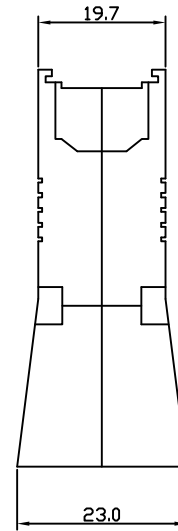

MPH02-50-XXXX

LSMC:M2.6  
LSC:#4-40

UNLESS OTHERWISE SPECIFIED SURFACE FINISH ALL OVER TOLERANCES mm  METRIC X. = ±0.3 .X = ±0.2 .XX = ±0.1	DRAW:	DATE:	TITLE:
	<i>CHUBBY</i>	02/05/06	D-SUB MATEL HOOD R/A Type
	CHECK:	APPROVE:	MODEL CODE:
	KEVIN	<i>TONY</i>	MPH02-50-XXXX
			<b>誠州電子有限公司</b> <i>Sincere State Electronics Co.,Ltd.</i>

NO	DESCRIPTION	QTY