

CUST. MODEL:	REF.
CUST. P/N:	DWG FILE:

DESCRIPTION CONTROL			
REV.	DESC.	DATE	APP.

**RoHS Compliance**

NOTE:  
ZINE ALLOY NI PLATED  
FOR OD=7.0mm CABLE

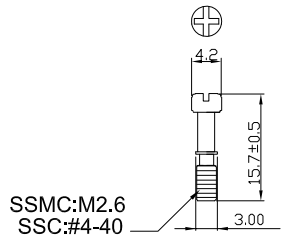

A  
2Pcs

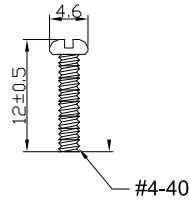

B  
2Pcs

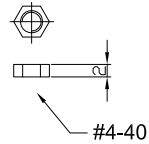

D  
2Pcs

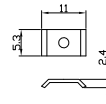

D  
2Pcs

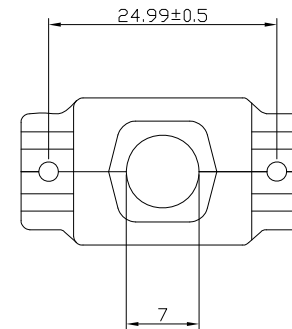
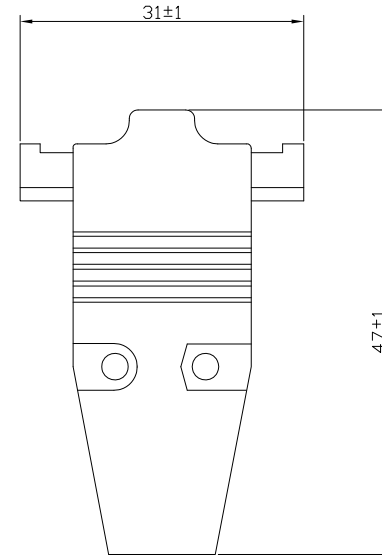
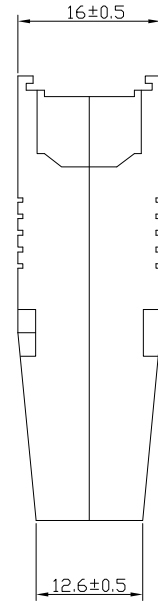

MPH02-09-XXXX

SSMC:M2.6  
SSC:#4-40

UNLESS OTHERWISE SPECIFIED SURFACE FINISH ALL OVER TOLERANCES mm  METRIC  .X = ±0.3 .XX = ±0.2	DRAW: <i>CHUBBY</i>	DATE: 02/05/06	TITLE: D-SUB MATEL HOOD Type
	CHECK: KEVIN	APPROVE: <i>TONY</i>	MODEL CODE: MPH02-09-XXXX
			<b>誠州電子有限公司</b> <i>Sincere State Electronics Co.,Ltd.</i>

NO	DESCRIPTION	QTY
----	-------------	-----