

CUST. MODEL:	REF.
CUST. P/N:	DWG FILE:

DESCRIPTION CONTROL			
REV.	DESC.	DATE	APP.

RoHS Compliance

NOTE:INSULATOR ABS UL94V-0 PLATED
METAL:STEEL/NICKEL PLATED

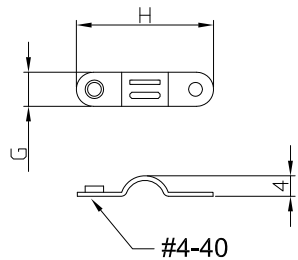

A
1Pcs

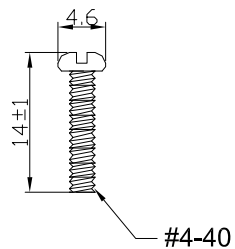

B
2Pcs

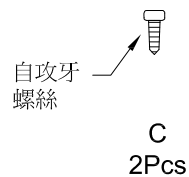

C
2Pcs

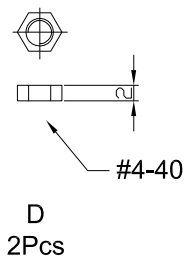

D
2Pcs

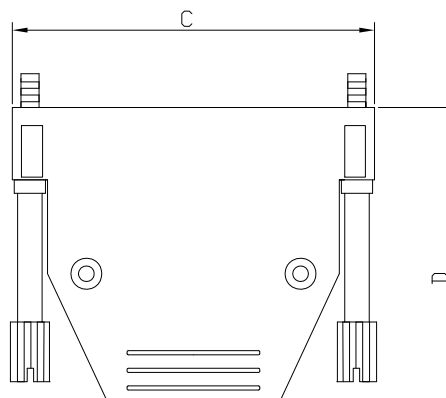
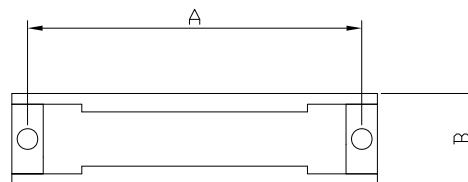

EA7-XX-SSC

09
15
25

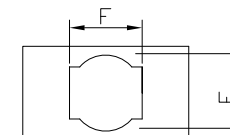

	A±0.3	B±0.2	C±0.5	D±0.5	E±0.5	F±0.3	G±0.3	H±0.5
EA7-09-SSC	25	18	31	29.8	9.2	11.9	5.7	16.5
EA7-15-SSC	32.7	18	43.2	36.9	10.4	12.8	5.8	19.3
EA7-25-SSC	47	18.2	55.3	41	11.2	14	6.5	26.5

UNLESS OTHERWISE SPECIFIED SURFACE FINISH ALL OVER TOLERANCES mm

METRIC

X. = ±0.3
.X = ±0.2
.XX = ±0.1

DRAW:

Chubby

DATE:

10/08/10

TITLE:

D-SUB EASY HOOD TYPE

MODEL CODE:

EA7-XX-SSC

CHECK:

KEVIN

APPROVE:

TONY

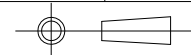

誠州電子有限公司

Sincere State Electronics Co.,Ltd.

NO	DESCRIPTION	QTY
----	-------------	-----